

ANTHOLOGY

STONE LOOK

Catalogue

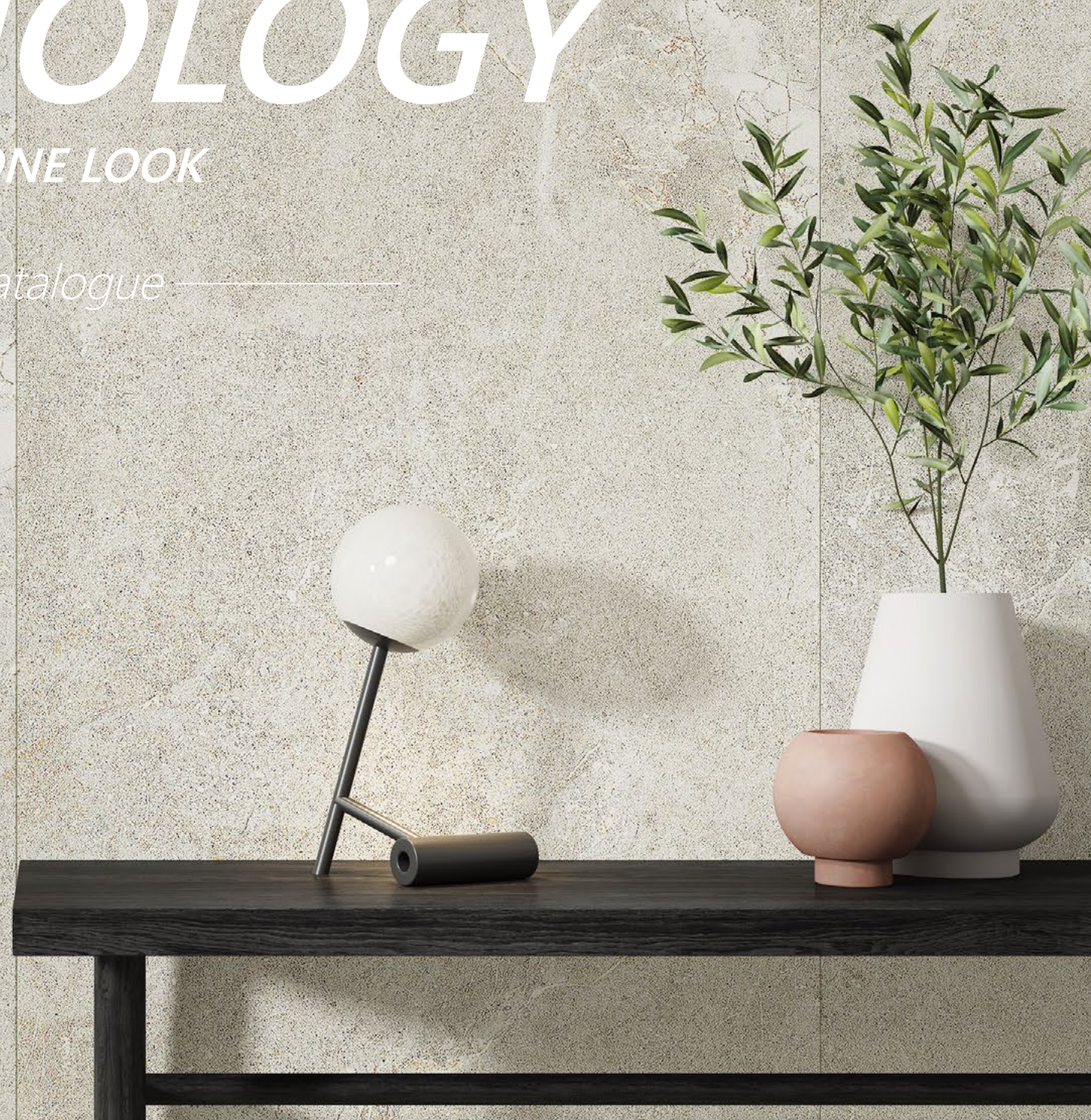



ASH
600x1200mm



AVAILABLE SIZES

- 600x1200mm
- 600x600mm
- 300x600mm
- 300x300mm

BULLNOSE DROP EDGE

600x400mm with a 40mm Drop Edge
Thickness:10mm

CRYSTAL

AVAILABLE SIZES

- 600x1200mm
- 600x600mm
- 300x600mm
- 300x300mm

BULLNOSE DROP EDGE

600x400mm with a 40mm Drop Edge
Thickness:10mm

CREMA

AVAILABLE SIZES

- 600x1200mm
- 600x600mm
- 300x600mm
- 300x300mm

BULLNOSE DROP EDGE

600x400mm with a 40mm Drop Edge
Thickness:10mm

ASH



AVAILABLE SIZES

- 600×1200mm
- 600×600mm
- 300×600mm
- 300×300mm

BULLNOSE DROP EDGE

600x400mm with a 40mm Drop Edge
Thickness:10mm

CRYSTAL



CRYSTAL
600×600mm



CRYSTAL
600×1200mm

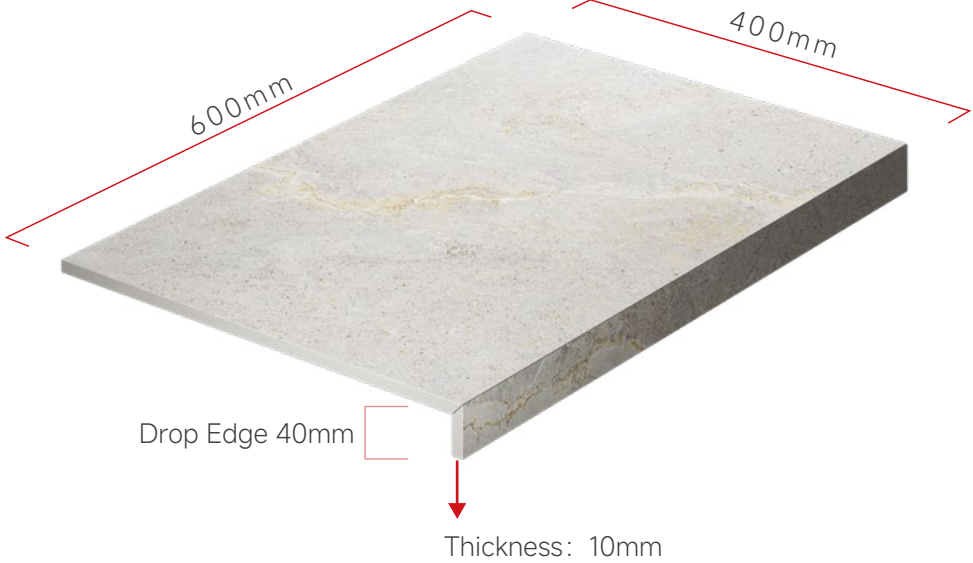

**BULLNOSE DROP EDGE 600X400MM
WITH A 40MM DROP EDGE**



CRYSTAL
Bullnose Drop Edge 600x400mm



AVAILABLE SIZES

- 600×1200mm
- 600×600mm
- 300×600mm
- 300×300mm

BULLNOSE DROP EDGE

600x400mm with a 40mm Drop Edge
Thickness:10mm

CREMA



CREMA
600×600mm



CREMA
600×1200mm

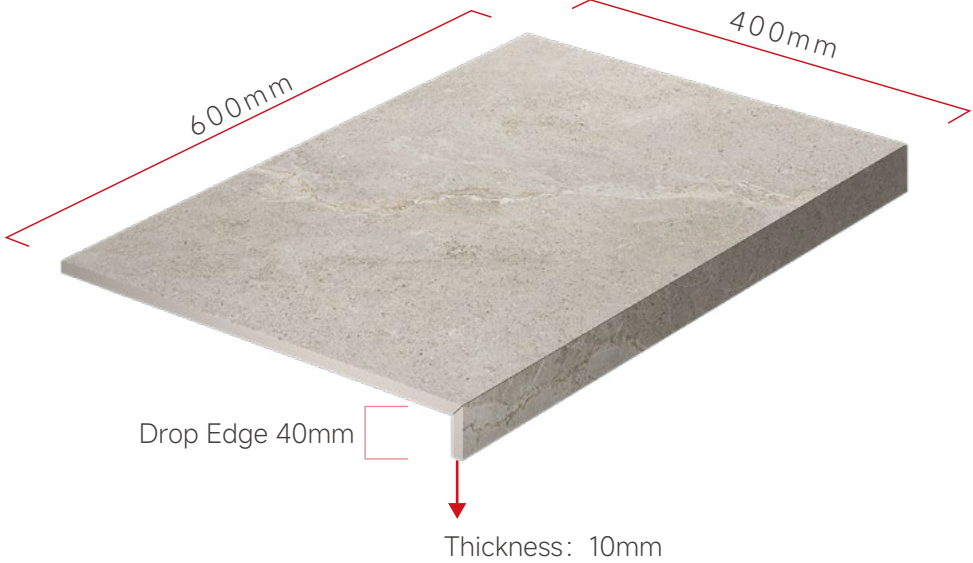

**BULLNOSE DROP EDGE 600X400MM
WITH A 40MM DROP EDGE**



CREMA
Bullnose Drop Edge 600x400mm



AVAILABLE SIZES

- 600×1200mm
- 600×600mm
- 300×600mm
- 300×300mm

BULLNOSE DROP EDGE

600x400mm with a 40mm Drop Edge
Thickness:10mm

ASH



ASH
600×1200mm



ASH
600×1200mm

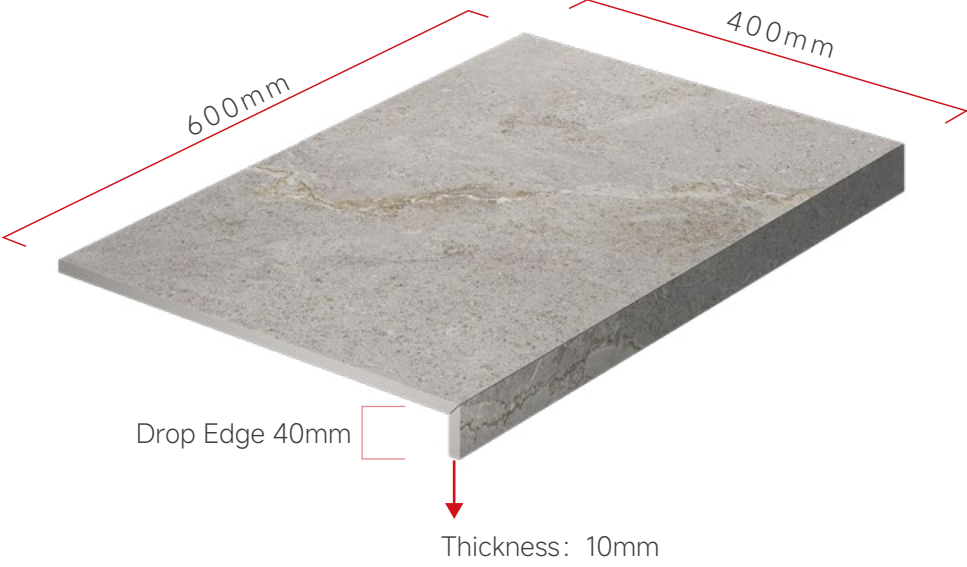

**BULLNOSE DROP EDGE 600X400MM
WITH A 40MM DROP EDGE**



SURFACE

APPLICATION

PRODUCT SUMMARY

- (M) MATT
- (E) EXTERNAL
- (WALL TILES)
- (FLOOR TILES)
- (MIN. LAYING GAP 3mm)
- (03) COLOURS
- (05) SIZES
- (02) FINISHES

RANDOM FACES

Please note: Tile patterns are random and may not represent exactly as shown in the photo.



CRYSTAL | 600x1200mm



CRYSTAL | 600x600mm

SURFACE

APPLICATION

PRODUCT SUMMARY

- (M) MATT (E) EXTERNAL (W) WALL TILES (F) FLOOR TILES (G) MIN. LAYING GAP 3mm (03) COLOURS (05) SIZES (02) FINISHES

ACCESSORIES

BULLNOSE DROP EDGE 600X400MM



CRYSTAL



CREMA



ASH

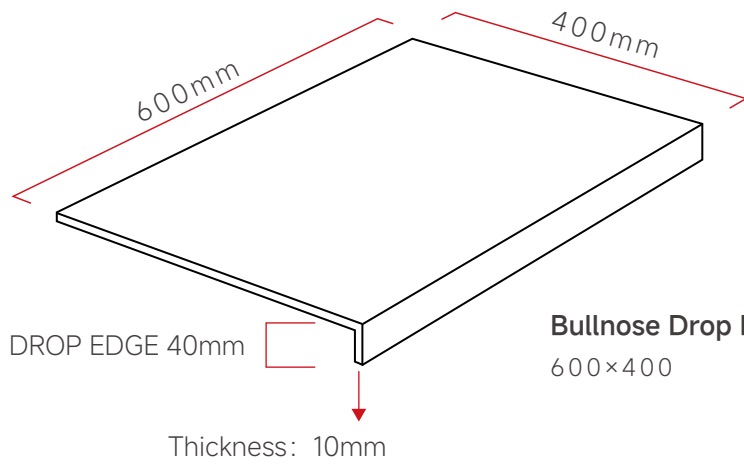

Bullnose Drop Edge 600x400mm with a 40mm drop edge
600x400



CRYSTAL
600×600mm









CREMA
600×600mm









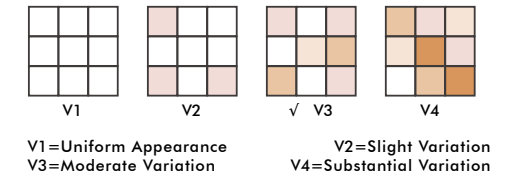



ASH
600×1200mm

PRODUCT SUMMARY





 V3 TEXTURE RATING	 MIN. LAYING GAP 3mm	 RECTIFIED	 WALL TILES	 FLOOR TILES	 COLOURS	 FINISHES
--	---	--	---	--	--	---



TECHNICAL SPECIFICATION

MEASUREMENT AND SURFACE APPEARANCE	STANDARD PRESCRIBED VALUES	MANUFACTURER'S VALUES (600×600mm)	MANUFACTURER'S VALUES (600×1200mm)
TECHNICAL SPECIFICATION			
 Length and width	±0.6% max .	-0.03-0.03% max .	-0.03-0.03% max .
 Thickness	±5% max .	9.0-9.5% max .	10.0-10.5% max .
 Orthogonality	±0.5% max .	-0.06-0.07% max .	-0.06-0.07% max .
 Straightness of sides	±0.5% max .	-0.06-0.07% max .	-0.02-0.03% max .
 Surfaces flatness	±0.5% max .	-0.05-0.07% max .	-0.09-0.11% max .
 V rating	V3	V3	V3
PHYSICAL PROPERTIES			
 Water absorption	0.5 < WA ≤ 1%	0.5 < WA ≤ 1%	0.5 < WA ≤ 1%
 Breaking strength	≥ 1300N	2265N	4031N
 Bending resistance	≥ 35N/mm ²	38N/mm ²	40N/mm ²
 Resistance to deep abrasion	≤ 175mm ³	Class 4	Class 4
 Temperature shock resistance	No visible crack	No visible crack	Durable
 Resistance to frost	No visible crack	No visible crack	No visible crack
 Non-slip	P3-P4	P3-P4	P3-P4
 Colour resistance to light	no colour changes	no colour changes	no colour changes
CHEMICAL PROPERTIES			
 Chemical resistance	no visible changes when subjected to chemicals	Durable	Durable
 Resistance to staining	≥ 3	Class 5	Class 5

PACKING DETAILS

SIZE	SURFACE		PCS/CTN	m ² /CTN	KG/CTN
	MATT	EXTERNAL			
600x1200mm	√		2	1.44	40
600x600mm	√	√	4	1.44	31.5
300x600mm	√	√	8	1.44	31.5
300x300mm	√		11	0.99	31.5
600x400mm (BULLNOSE WITH 40MM DROP)		√	2	0.53	31.5

ANTHOLOGY
CATALOGUE